



**STD 7000**

**7602  
Output Port Card**

**USER'S MANUAL**

**7602**  
**Output Port Card**  
**USER'S MANUAL**

PRELIMINARY

# 7000 STD BUS

# 7602 OUTPUT PORT CARD

## TTL OUTPUT PORT CARD

This card provides eight 8-bit latched output ports (64 output lines).

Output port lines are accessed at 16-pin DIP sockets on the card. The output lines are TTL compatible with the ability to drive 20 low-power Schottky TTL loads each (5 TTL loads). A reset line is available to clear all ports simultaneously.

The 7602 decodes eight address lines with provision for expansion and memory mapping. An on-card jumper system allows users to establish the eight consecutive output port addresses occupied by the 7602.

### FEATURES

- User selectable port address (256 port field)
- Output Drive: 20 low-power Schottky TTL loads
- Provision for expansion and memory mapping
- All IC's socketed
- Single +5V operation

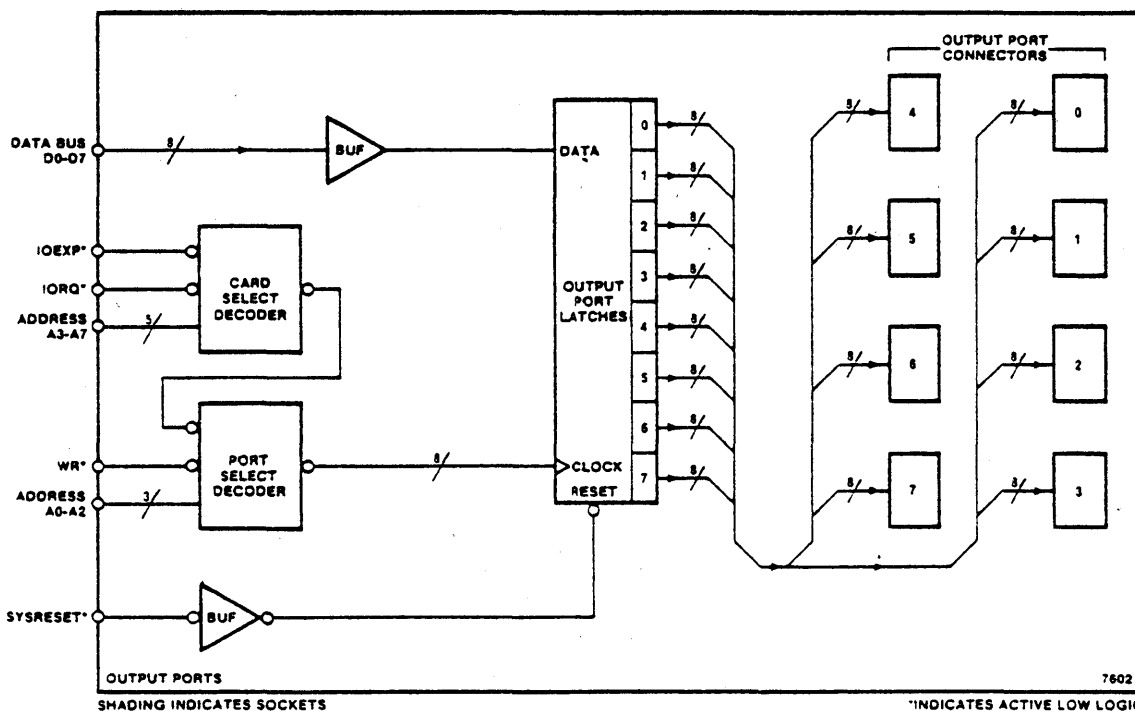
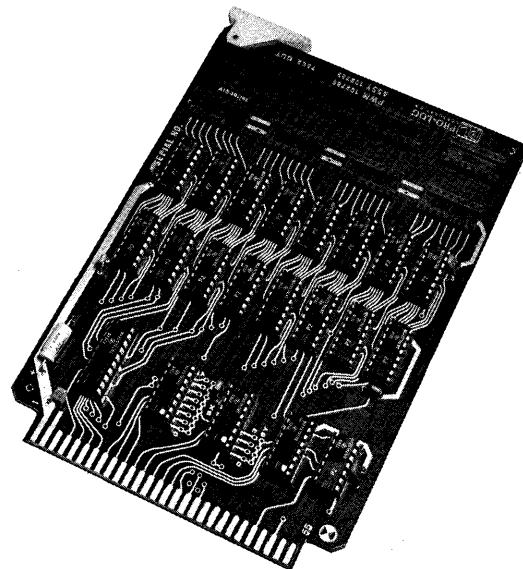

### 3. Card Address Mapping

The 7602 card is selected by a decoded combination of address lines A3-A7. The user chooses the card address combination by connecting one jumper wire each from SX and SY to pad matrices adjacent to U2 and U3 (See Diagram). The 7602 is shipped with Port address 00-07 Hexadecimal. To map the 7602 anywhere in the hexadecimal range of 00-FF change the decoder outputs connected to SX and SY.

#### Port Addresses

Address lines A0, A1 and A2 select one of eight sequential output port addresses. The WR\* input controls the output latch function.

### 4. ADDRESS DECODER OPERATION

Refer to the schematic, document #102788.

The 7602 uses two cascaded 74LS42 decoders (U2, U3) to decode address lines A3-A7. These decoders are enabled only when IORQ\* and IOEXP\* are active. Address lines A0, A1, A2 and the WR\* signal are used to gate the select strobes (which control the output ports) from U4.

#### CHANGING THE 7602's PORT ADDRESS

Refer to the assembly diagram, document #102789. Locate decoders U2 and U3, (74LS42) adjacent to the STD BUS edge connector. Each decoder device has a dual row of pads which form decoder output select matrices. Make one (and only one) connection to each of the matrices adjacent to U2 and U3.

The decoder jumper pads numbered as shown in Figure 3 are adjacent to the decoder chips on the 7602. Also shown are the jumpers (at X0 and Y0) which produce hexadecimal port addresses 00, 01, 02 thru 07, the selections made when the card is shipped.

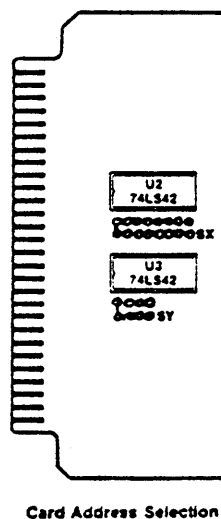



FIGURE 3 - DECODER JUMPER PAD NUMBERING

5. 7602 CARD ENVIRONMENTAL SPECIFICATIONS

RECOMMENDED OPERATING LIMITS				ABSOLUTE NON-OPERATING LIMITS		
PARAMETER	MIN	TYP	MAX	MIN	MAX	UNITS
Free Air Temperature	0	25	55	-40	75	°C
Humidity 	5		95	0	95	%RH

 Non-condensing



7. MECHANICAL

- Meets all STD BUS general mechanical specifications
- May require one additional card slot width for ribbon cable access to output port sockets (connector dependent).
- Connectors use low profile 16-pin DIP plugs with heavy duty pins. T & B Ansley Catalog No. 609-MH165H or equivalent.

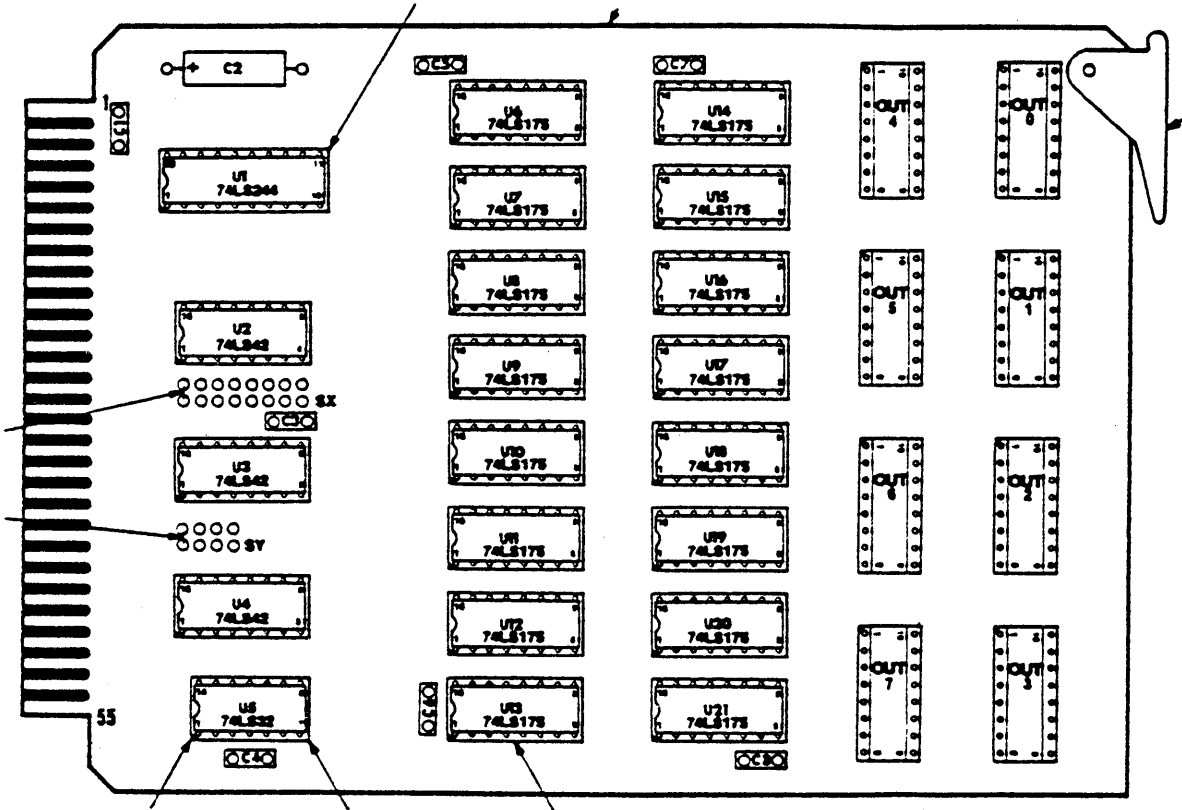

FIGURE 5 - 7602 ASSEMBLY

## 8. 7602 OPERATING SUBROUTINE MODULES

This section provides flow diagrams and subroutines to operate your 7602 card. These may be used intact, or used as models to construct subroutines for a specific application.

The subroutines are written in 8080-family assembly code and will execute on 8080, 8085, and Z80 processors. The memory addresses selected are compatible with Pro-Log's 7801 (8085A) and 7803 (Z80) processor cards. The 7602 port addresses used are the address jumper selections made when the 7602 is shipped.

To use these subroutines in systems other than those described above, the memory and/or I/O port addresses may require change for compatibility.

The flow diagrams presented can be easily translated into the assembly code used by any microprocessor since they show the steps required to achieve 7602 operation without reference to a particular microprocessor.

The following routines can set or clear a bit or bits on an output port. To use the routines load the accumulator with the bits that should be changed and set the HL pointer to a place in memory where the port status is stored.

8 7 6 5 4 3 2 1

REVISIONS			
NO.	DATE	DESCRIPTION	BY
1		ASSEMBLY DRAWING PRO-LOG CORPORATION PART 102789	

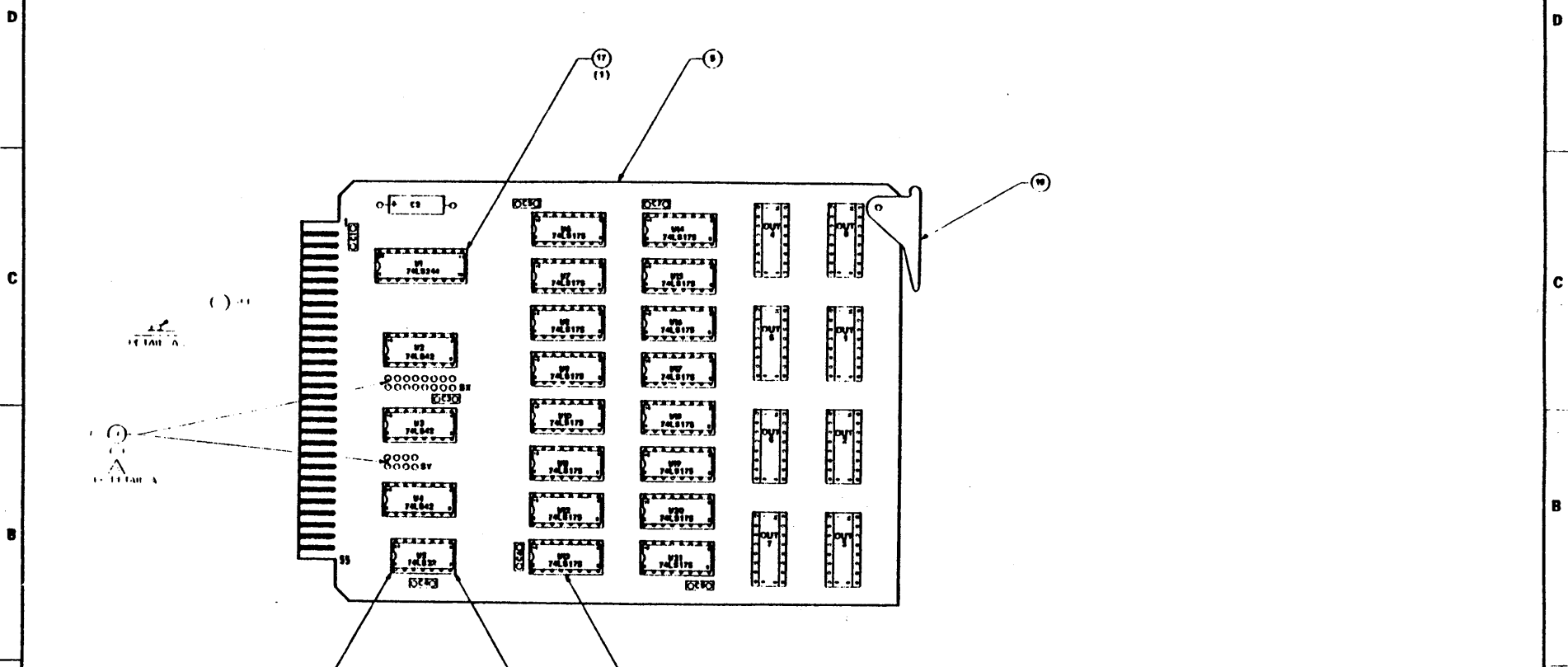

( )

( )

REFERENCE ONLY

(A) INDICATES PIN NO. OF SOCKETS (TYP.)  
FOR ASSEMBLY DRAWINGS SEE ASSEMBLY  
DRAWINGS UNLESS OTHERWISE SPECIFIED

SCHEMATIC NO. 102789A  
PARTS LIST NO. 102789

ITEM	DESCRIPTION	QTY	UNIT	REV.	DATE
	PRO-LOG CORPORATION				
	ASSEMBLY				
	OUTPUT LATCH CARD				
	D 102789				

101356 8 7 6 5 4 3 2 1



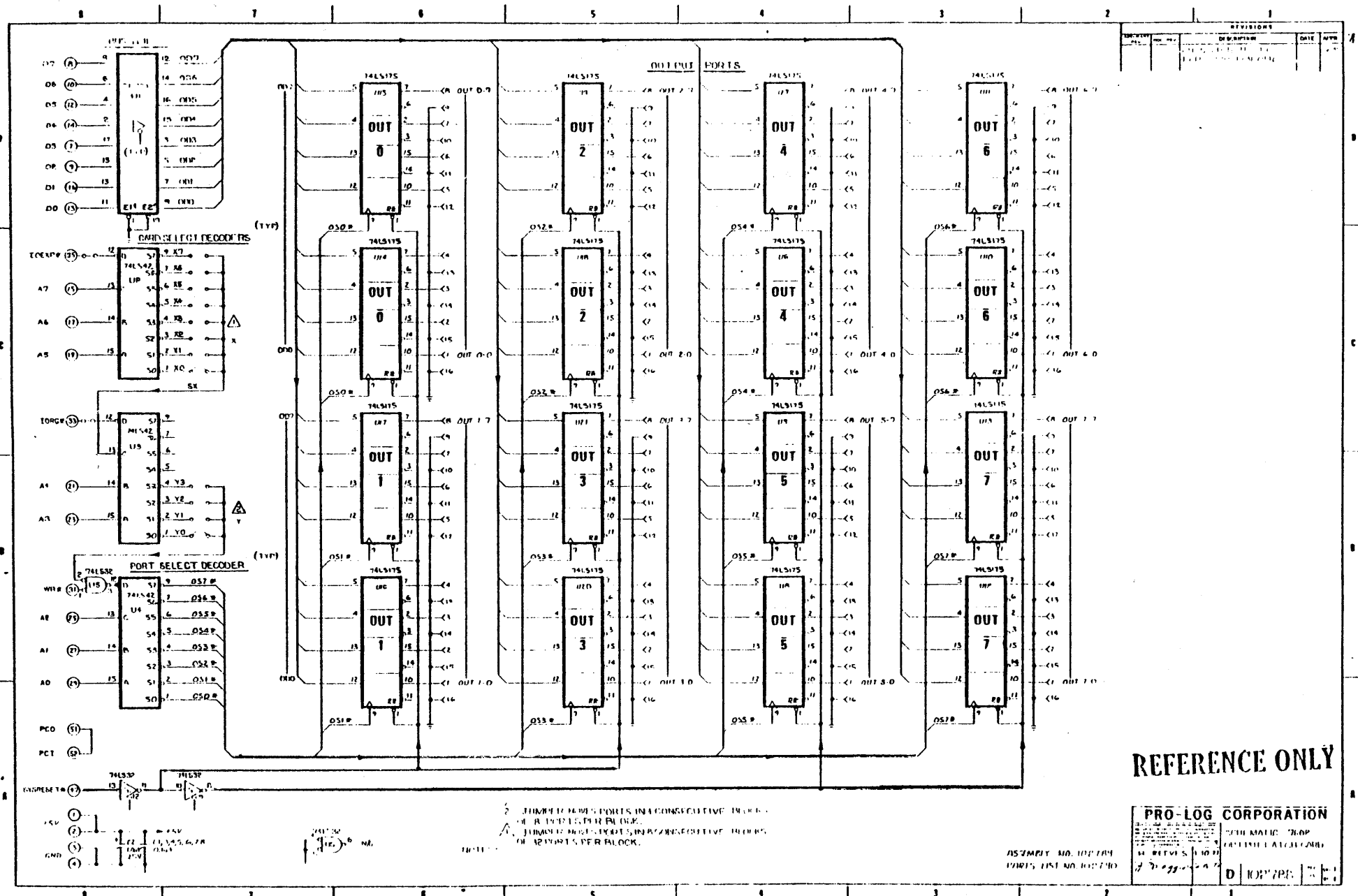

REVISIONS			
REV.	DATE	DESCRIPTION	BY

**REFERENCE ONLY**

**PRO-LOG CORPORATION**  
 2000 MATHIC TRAIL  
 FARMINGDALE, N.Y. 11735  
 (516) 754-1000  
 FAX (516) 754-1001  
 D 100770

JUMPER TO MAKE PORTS IN A CONSECUTIVE BLOCK  
 OF 8 PORTS PER BLOCK.  
 JUMPER TO MAKE PORTS IN A CONSECUTIVE BLOCK  
 OF 4 PORTS PER BLOCK.

ASSEMBLY NO. 100770  
 PARTS LIST NO. 100770



**USER'S MANUAL**



**2411 Garden Road  
Monterey, California 93940  
Telephone: (408) 372-4593  
TWX: 910-360-7082**